



Item No. :502004-30

Assembly Instruction

Hardware

No.	Draw	Qty
A		2 PCS
B		2 PCS
C		2 PCS

Step1

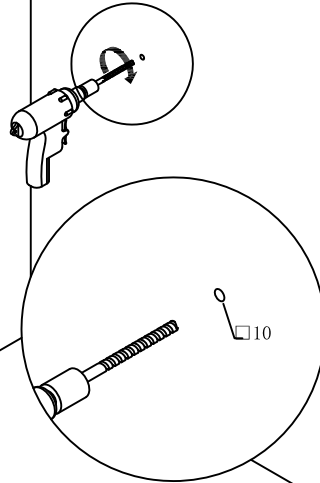

Step2

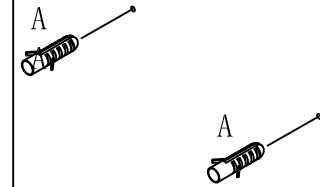

Step3

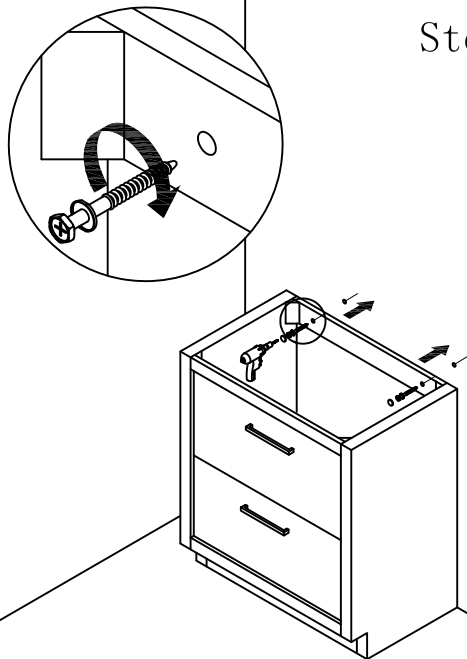

Step4

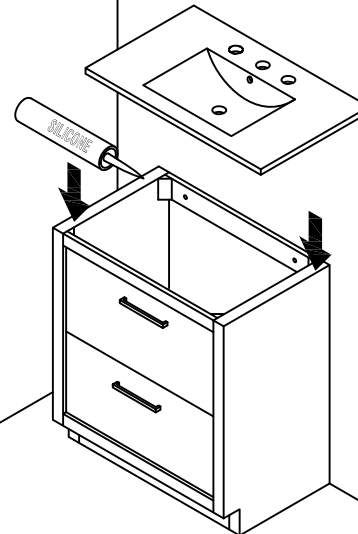

Finished

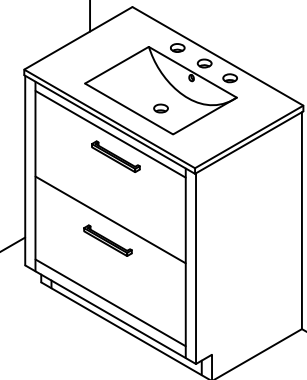

Description:
Main Cabinet
Size:
750x470x850mm

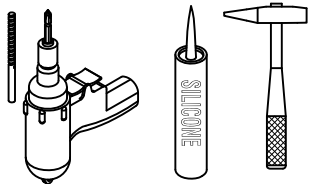

Tools:



Item No. :502004-30

Assembly Instruction

Hardware

No.	Draw	Qty
A		4 PCS
B		4 PCS

Step1

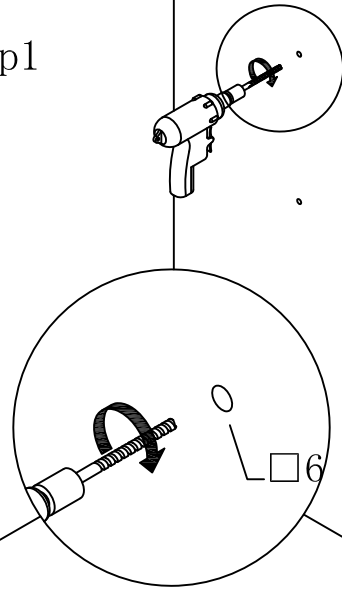

Step2

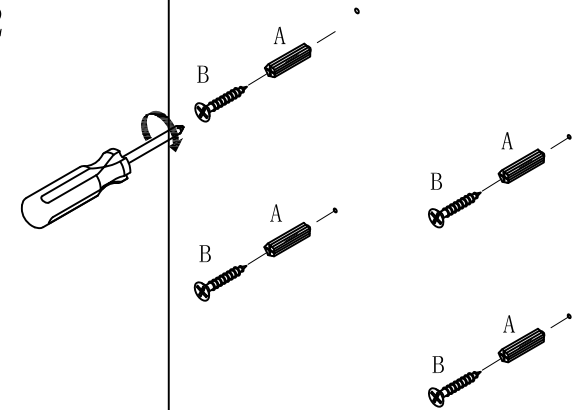

Step3

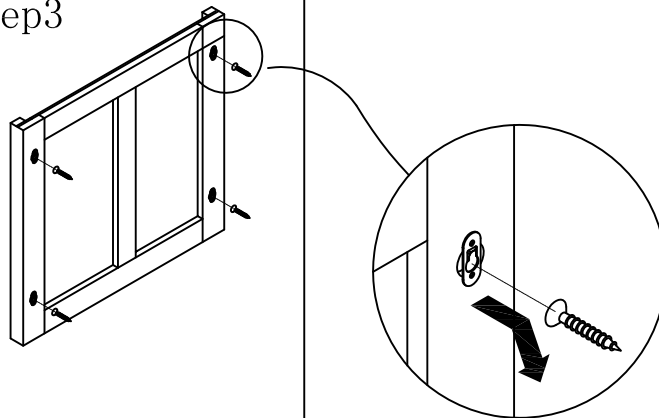

Finished

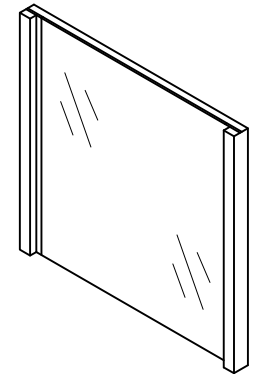

Description:

Mirror

Size:

750x43x650mm

Tools:

